

HRTL 96B

Laser light scanner with background suppression

en 02-2014/07 50113487-01



Dimensioned drawing

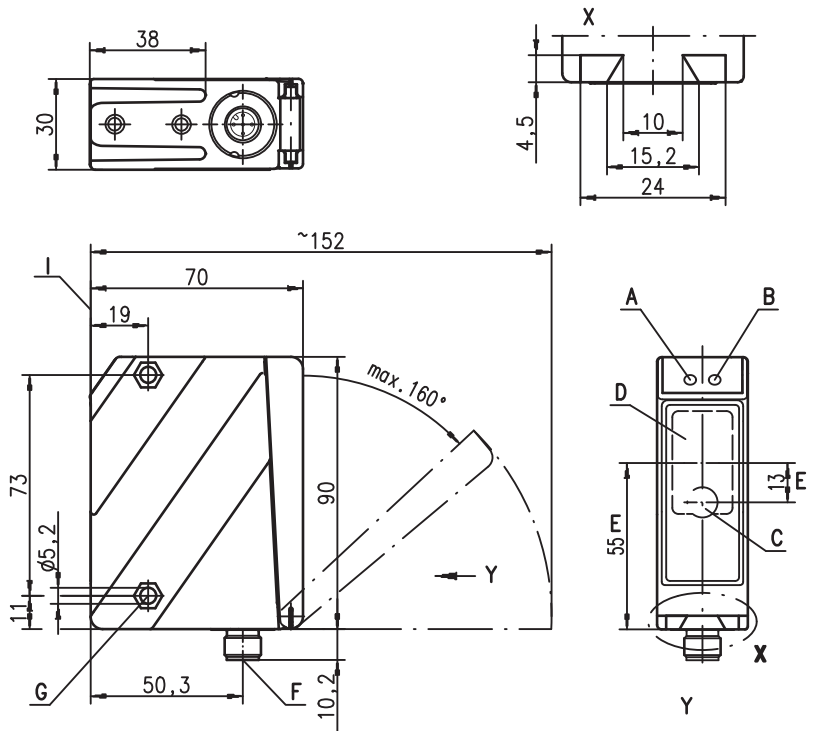

- A** Green indicator diode
- B** Yellow indicator diode
- C** Transmitter
- D** Receiver
- E** Optical axis
- F** Device plug M12x1
- G** Countersinking for SK nut M5, 4.2 deep
- H** Key pad
- I** Reference edge for the measurement (cover glass)
- K** OUT1 scanning range adjustment
- L** Indicator diodes yellow for OUT1 switching output

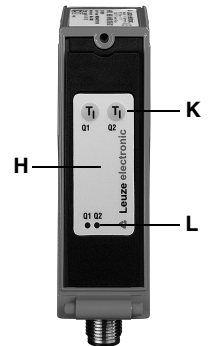

50 ... 6,500mm

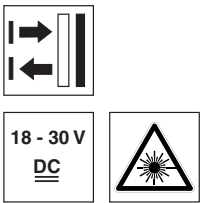

- Laser class 2
- Laser light scanner based on the principle of light propagation time measurement – simple operation using teachable switching points
- Sensor performance allows reliable detection of both glossy and less-reflective objects at extreme angles
- Automatic reserve and hysteresis ensure reliable switching behavior
- Optimized for positioning applications and reliable object detection (e.g. compartment occupation check, shelf positioning, feed-through monitoring)
- External teach input for precise referencing (detection and storage of distance to the object)
- Teach input allows external selection of the sensor performance (e.g. switching from compartment occupation check to feed-through monitoring)
- Deactivation input for checking the switch function and resetting to output mode (status before teach-in)

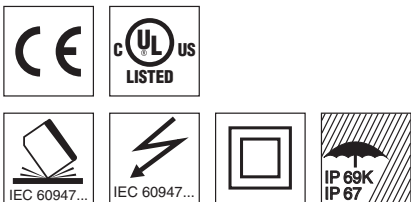

Accessories:

- (available separately)
- Mounting systems (BT 96, BT 96.1, UMS 96, BT 450.1-96)
 - M12 connectors (KD ...)
 - Ready-made cables (K-D ...)

Electrical connection

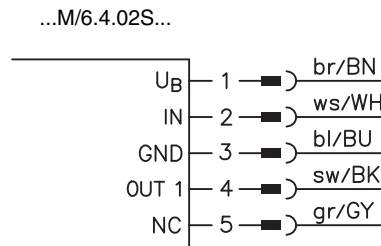

Pin 2 = teach input

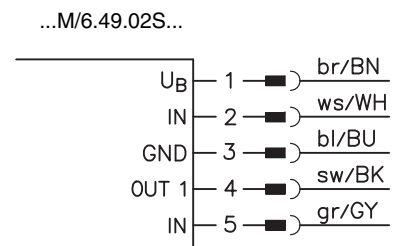

Pin 2 = teach input
Pin 5 = deactivation input

We reserve the right to make changes • DS_HRTL96B64x02S_TOF_en_50113487_01.fm

Specifications

Optical data

| | |
|---|---|
| Typ. scanning range limit (white 90%) ¹⁾ | 50 ... 6500mm |
| Scanning range ²⁾ | 100 ... 6000mm |
| Adjustment range / teach-in range | 150 ... 6000mm / 6 ... 90% diffuse reflection |
| Light source | laser (red light), pulsed |
| Light spot diameter | 1m:6mm / 3m:5mm / 5m:4mm / 7m:4mm |
| Wavelength | 658 nm |
| Max. output power | < 248 mW |
| Pulse duration | 6.5ns |

Timing

| | |
|-----------------------|---------|
| Switching frequency | 100Hz |
| Response time | 5ms |
| Delay before start-up | ≤ 200ms |

Electrical data

| | |
|---------------------------------------|---|
| Operating voltage U_B ³⁾ | 18 ... 30VDC (incl. residual ripple) |
| Residual ripple | ≤ 15% of U_B |
| Open-circuit current | ≤ 120mA |
| Switching output | .../6... 1 push-pull switching output ⁴⁾ |
| | PNP light switching, NPN dark switching |
| Signal voltage high/low | ≥ ($U_B - 2V$) / ≤ 2V |
| Output current | max. 100mA |

Indicators

| | |
|---------------------|------------------------|
| Sensor front | |
| Green LED | ready |
| Yellow LED | reflection (Q1 = OUT1) |
| Sensor back | see table |

Mechanical data

| | |
|----------------------|----------------------|
| Metal housing | |
| Housing | diecast zinc |
| Optics cover | glass |
| Weight | 380g |
| Connection type | M12 connector, 5-pin |

Environmental data

| | |
|--|---|
| Ambient temperature (operation ⁵⁾ /storage) | -40°C ... +50°C / -35°C ... +70°C |
| Protective circuit ⁶⁾ | 1, 2, 3, 4 |
| VDE safety class ⁷⁾ | II, all-insulated |
| Degree of protection | IP 67, IP 69K ⁸⁾ |
| Laser class | 2 in accordance with DIN EN 60825-1:2008-05 |
| Standards applied | IEC 60947-5-2 |
| Certifications | UL 508, C22.2 No.14-13 ⁹⁾ ¹⁰⁾ |

- 1) Typ. scanning range limit: max. attainable range without performance reserve
- 2) Scanning range: recommended range with performance reserve
- 3) For UL applications: for use in class 2 circuits according to NEC only
- 4) The push-pull switching outputs must not be connected in parallel
- 5) Down to -30°C: Without restriction. Below -30°C: Sensor for voltage supply remains in place, the sensor becomes fully functional again approx. 3min. following reactivation of the voltage supply, if necessary, repeat the activation procedure
- 6) 1=transient protection, 2=polarity reversal protection, 3=short circuit protection for all outputs, 4=interference blanking
- 7) Rating voltage 250VAC
- 8) IP 69K test in accordance with DIN 40050 part 9 simulated, high pressure cleaning conditions without the use of additives, acids and bases are not part of the test
- 9) These proximity switches shall be used with UL Listed Cable assemblies rated 30V, 0.5A min, in the field installation, or equivalent (categories: CYJV/CYJV7 or PVVA/PVVA7)
- 10) CAUTION - Use of controls or adjustments or performance of procedures other than those specified herein may result in hazardous radiation exposure.

Operate in accordance with intended use.

- ⚠ This product is not a safety sensor and is not intended as personnel protection.
- ⚠ The product may only be put into operation by competent persons.
- ⚠ Only use the product in accordance with the intended use.

Tables

| Switching points | no reflection | object detected |
|------------------|---------------|-----------------|
| Yellow LED Q 1 | off | on |
| Yellow LED Q 2 | - | - |

Diagrams

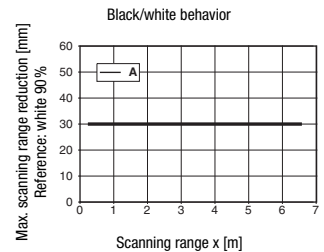

A 6 ... 90% diffuse reflection

Remarks

- Setting the switching points:
Align sensor with object.
Q1: Press teach button 1 for approx. 2s, release when the LED starts flashing, teach in of switching point complete.
The object has been detected when Q1 indicator lights up.
- Reserve: For the reliable detection of objects with low reflectance, a reserve is automatically added during the teach event. This is constant over the entire teach range.
Object is detected:
distance to sensor ≤ teach point + reserve
- Hysteresis: To ensure continuous object detection in the switching point, the sensor has a switch-off hysteresis.
Object is no longer detected if:
distance to sensor > teach-in point + reserve + hysteresis.
- Factory settings:
Compartment occupation check
reserve: approx. 50mm
hysteresis: approx. 50mm
Feed-through monitoring
reserve: approx. 25mm
hysteresis: approx. 15mm
- Object detection:
resolution < 5mm, standard deviation ±10mm at ±3 Sigma
- Edge detection/shelf positioning:
repeatability < 1mm
- With the set scanning range, a tolerance of the upper scanning range limit is possible depending on the reflection properties of the material surface.
- Window function: object is detected at distance switching point ± window width (for feed-through monitoring).
- Scanning range/reflectivity:

| Object/diffuse reflection | |
|---------------------------|------------------------|
| 6 ... 90% | 0.15 ... 6m (standard) |

HRTL 96B

Laser light scanner with background suppression

Part number code

| | | | | | | | | | | | | | | | | | | | |
|---|---|---|---|---|---|---|---|---|---|---|---|---|---|---|---|---|---|---|---|
| H | R | T | L | 9 | 6 | B | / | 6 | . | 4 | 9 | . | 0 | 2 | S | - | S | 1 | 2 |
|---|---|---|---|---|---|---|---|---|---|---|---|---|---|---|---|---|---|---|---|

Operating principle

HRT Diffuse reflection light scanners with background suppression

Operating principle

L Laser (red light)

Construction/version

96B 96B Series

Switching output/function (OUT 1: pin 4, OUT 2: pin 2)

/6 1 x push-pull transistor output, OUT 1: light switching

Switching input

.4 Teach input (pin 2)

.9 Deactivation input (pin 5)

Equipment

.02 Customized configuration

Light-spot geometry

S Small light spot

Electrical connection

-S12 M12 connector, 5-pin (plug)

Order guide

The sensors listed here are preferred types; current information at www.leuze.com

| Order code | Part no. | Features |
|-----------------------|----------|---|
| HRTL 96B/6.4.02S-S12 | 50111815 | 1 x push-pull switching output, 1 x teach input |
| HRTL 96B/6.49.02S-S12 | 50112803 | 1 x push-pull switching output, 1 x teach input, 1 x deactivation input |

Laser safety notices

⚠ ATTENTION, LASER RADIATION – LASER CLASS 2

Never look directly into the beam!

The device fulfills the EN 60825-1:2008-05 (IEC 60825-1:2007) safety regulations for a product in **laser class 2** as well as the U.S. 21 CFR 1040.10 regulations with deviations corresponding to "Laser Notice No. 50" from June 24th, 2007.

- ↳ Never look directly into the laser beam or in the direction of reflecting laser beams!
If you look into the beam path over a longer time period, there is a risk of injury to the retina.
- ↳ Do not point the laser beam of the device at persons!
- ↳ Intercept the laser beam with an opaque, non-reflective object if the laser beam is accidentally directed towards a person.
- ↳ When mounting and aligning the device, avoid reflections of the laser beam off reflective surfaces!
- ↳ **CAUTION!** Use of controls or adjustments or performance of procedures other than specified herein may result in hazardous light exposure.
The use of optical instruments or devices (e.g., magnifying glasses, binoculars) with the product will increase eye hazard.
- ↳ Adhere to the applicable legal and local regulations regarding protection from laser beams acc. to EN 60825 (IEC 60825) in its latest version.
- ↳ The device must not be tampered with and must not be changed in any way.
There are no user-serviceable parts inside the device.
Repairs must only be performed by Leuze electronic GmbH + Co. KG.

NOTICE

Affix laser information and warning signs!

Laser information and warning signs are affixed to the device (see ①). In addition, self-adhesive laser information and warning signs (stick-on labels) are supplied in several languages (see ②).

- ↳ Affix the laser information sheet with the language appropriate for the place of use to the device.
When using the device in the US, use the stick-on label with the "Complies with 21 CFR 1040.10" notice.
- ↳ Affix the laser information and warning signs near the device if no signs are attached to the device (e.g. because the device is too small) or if the attached laser information and warning signs are concealed due to the installation position.
Affix the laser information and warning signs so that they are legible without exposing the reader to the laser radiation of the device or other optical radiation.

①



A Laser exit opening
B Laser warning sign

②

50108905-03

| | |
|--|---|
| <p style="text-align: center; font-size: small;">LASERSTRAHLUNG NICHT IN DEN STRAHL BLICKEN</p> <p style="font-size: x-small;">Max. Leistung (peak): 248 mW Impulsdauer: 6.5 ns Wellenlänge: 658 nm</p> <p style="text-align: center; font-size: x-small;">LASER KLASSE 2 DIN EN 60825-1:2008-05</p> | <p style="text-align: center; font-size: small;">RADIACIONE LASER NON FISSARE IL FASCIO</p> <p style="font-size: x-small;">Potenza max. (peak): 248 mW Durata dell'impulso: 6.5 ns Lunghezza d'onda: 658 nm</p> <p style="text-align: center; font-size: x-small;">APPARECCHIO LASER DI CLASSE 2 EN 60825-1:2007</p> |
| <p style="text-align: center; font-size: small;">LASER RADIATION DO NOT STARE INTO BEAM</p> <p style="font-size: x-small;">Maximum Output (peak): 248 mW Pulse duration: 6.5 ns Wavelength: 658 nm</p> <p style="text-align: center; font-size: x-small;">CLASS 2 LASER PRODUCT EN 60825-1:2007</p> | <p style="text-align: center; font-size: small;">RAYONNEMENT LASER NE PAS REGARDER DANS LE FASCIEAU</p> <p style="font-size: x-small;">Puissance max. (crête): 248 mW Durée d'impulsion: 6.5 ns Longueur d'onde: 658 nm</p> <p style="text-align: center; font-size: x-small;">APPAREIL À LASER DE CLASSE 2 EN 60825-1:2007</p> |
| <p style="font-size: x-small;">AVOID EXPOSURE – LASER RADIATION IS EMITTED FROM THIS APERTURE</p> | |
| <p style="text-align: center; font-size: small;">RADIACION LASER NO MIRAR FIJAMENTE AL HAZ</p> <p style="font-size: x-small;">Potencia max. (peak): 248 mW Duración del impulso: 6.5 ns Longitud de onda: 658 nm</p> <p style="text-align: center; font-size: x-small;">PRODUCTO LASER DE CLASE 2 EN 60825-1:2007</p> | <p style="text-align: center; font-size: small;">RADIACÃO LASER NÃO OLHAR FIXAMENTE O FEIXE</p> <p style="font-size: x-small;">Potência max. (peak): 248 mW Período de pulso: 6.5 ns Comprimento de onda: 658 nm</p> <p style="text-align: center; font-size: x-small;">EQUIPAMENTO LASER CLASSE 2 EN 60825-1:2007</p> |
| <p style="text-align: center; font-size: small;">LASER RADIATION DO NOT STARE INTO BEAM</p> <p style="font-size: x-small;">Maximum Output (peak): 248 mW Pulse duration: 6.5 ns Wavelength: 658 nm</p> <p style="text-align: center; font-size: x-small;">CLASS 2 LASER PRODUCT EN 60825-1:2007 Complies with 21 CFR 1040.10</p> | <p style="text-align: center; font-size: small;">激光辐射 勿直视光束</p> <p style="font-size: x-small;">最大输出 (峰值): 248 mW 脉冲持续时间: 6.5 ns 波长: 658 nm</p> <p style="text-align: center; font-size: x-small;">2 类激光产品 GB7247.1-2012</p> |



HRTL 96B

Laser light scanner with background suppression

HRTL 96B/6.4.02S-S12 window teach-in - stop pallet movement of high-bay storage device

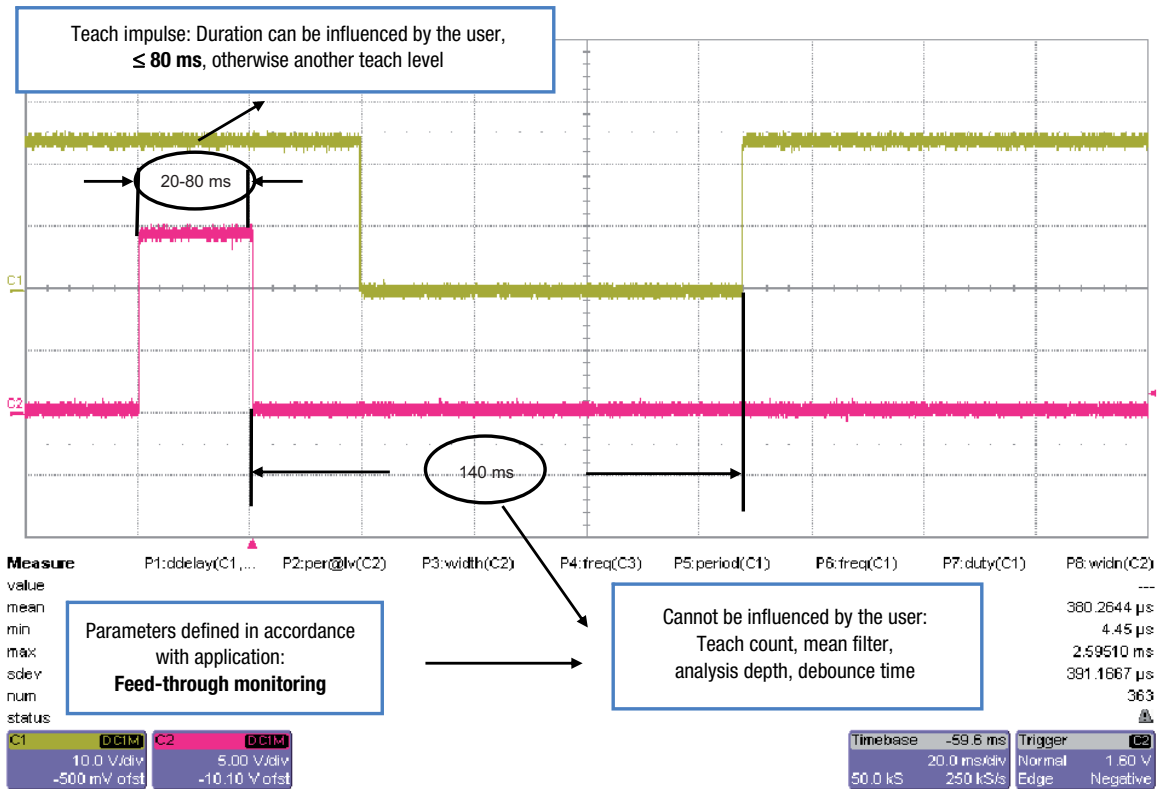

Application examples

Combined compartment occupation check and feed-through monitoring with HRTL 96B M/6.49.02S-S12 (50112803)

Process:

- High-bay storage device has reached its target position (X/Y).
- The HRTL 96 is in compartment occupancy mode (scanning range can be defined using the teach button, e.g. standard distance to pallet in depth 2).
- No detection of pallet signifies fork not extended.
Possible cause:
 - No pallet present
 - Pallet outside of tolerance range (e.g. not set down properly during the bring procedure)
 - **OUT1 switching output (pin 4) = inactive**
- Pallet detected:
 - Switch sensor over from **compartment occupancy mode** to **feed-through mode**
 - **External teach-in via teach input (pin 2)**
The actual distance to the pallet is measured and stored (set > 20ms input).
 - Window teach-in, thus a window of approx. ± 30mm is set automatically around the teach point.
 - **Teach-in okay: OUT1 output (pin 4) = active**
- Start fork cycle:
 - In the event of a crash between fork and pallet, the distance to the sensor changes:
Distance of sensor to pallet > (teach distance + window)
 - **OUT1 switching output (pin 4) inactive**
 - **Stop fork, prevent the pallet from falling**
 - Distance from sensor to pallet does not change
 - **Fork cycle is concluded and pallet is set down on high-bay storage device.**
- Resetting of sensor:
 - **Set deactivation input (pin 5 = active)**
- Approach next target...



Feed-through monitoring with HRTL 96B M/6.4.02S-S12 (50111815) via external teach-in

Process:

- High-bay storage device has reached its position
- Set teach input for > 20ms
→ **External teach-in via teach input (pin 2)**
The actual distance to the pallet is measured and stored.
 - Window teach-in, thus a window of approx. ± 30mm is set automatically around the teach point.
 - **Teach-in okay: OUT1 output (pin 4) = active**
- Start fork cycle:
 - In the event of a crash between fork and pallet, the distance to the sensor changes:
Distance of sensor to pallet > (teach distance + window)
 - **OUT1 switching output (pin 4) inactive**
 - **Stop fork, prevent the pallet from falling**
 - Distance from sensor to pallet does not change
 - **Fork cycle is concluded and pallet is set down on high-bay storage device.**

